

DLB-150W/300W/450W/600W

Programmable Bluetooth Curve DC LOAD Meter

--User Manual--

2.4-inch HD color screen Bluetooth digital transmission curve version
battery capacity / DC power multi-function tester

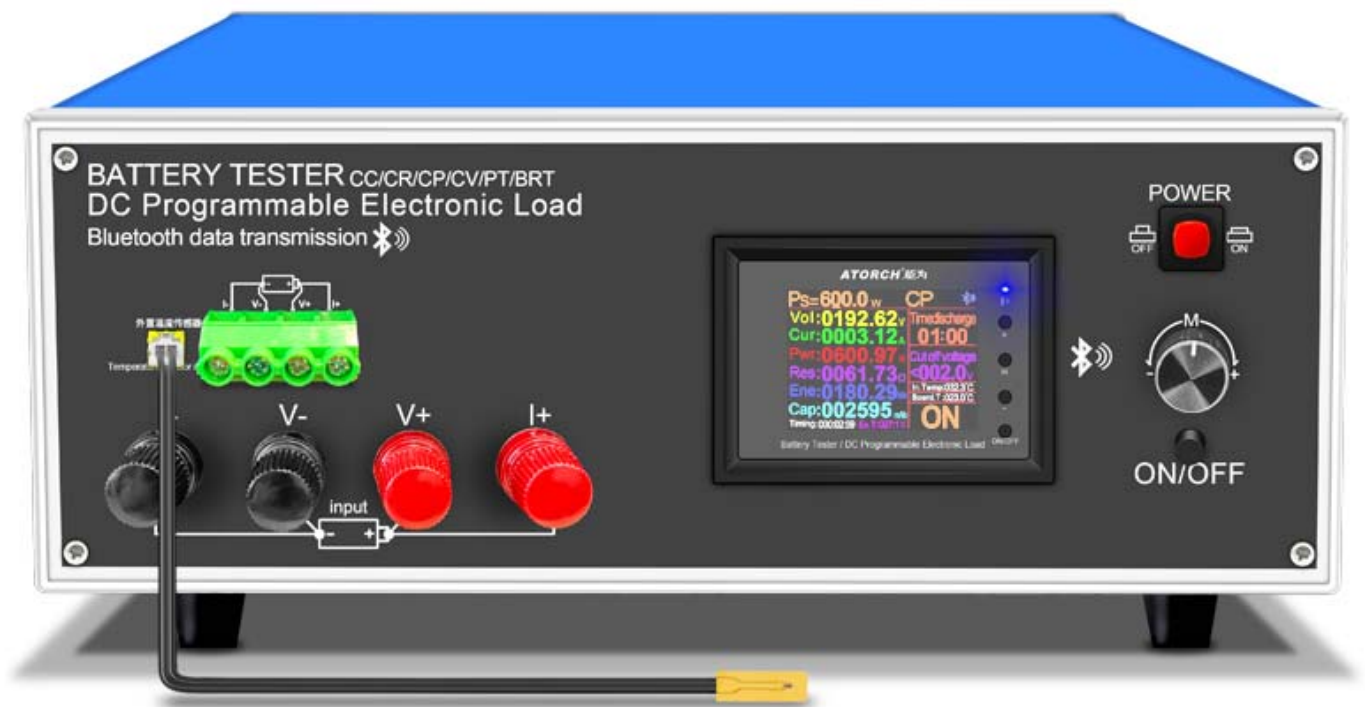

(This product will be updated at any time, please pay attention to the web page description for detailed update details)

-- Product Parameter --

1. Electrical parameters (V*A<P<25°C)

Test voltage: 2~200V

Working current: 600W & 3mA~40A & >10V

DL24M Discharge power: voltage * current < 600W (V*A<P<25°C)

(The actual running current is limited by the maximum power, please adjust the current according to the law of energy conservation)

The built-in over-current, over-temperature, over-power safety protection functions, if the protection interface is popped up, please pay attention to the parameter adjustment, shall adjust to the maximum power, and then discharge, you can first slowly and smoothly adjust the preset value in the start and discharge, in order to adjust up to the maximum power for discharging.

2. Product Size:

型号 Product model	电压 Measuring voltage	放电电流 Discharge current	测试最大电流 (需要支持电压) Test maximum current (need to support voltage)	产品工作环境温度 @最大测试功率 Product working environment temperature @Max test power	产品报警温度 Product alarm temperature	产品工作 风扇分贝 Product working fan decibels	产品尺寸 Product Size
DLB-150W	2-200V	3mA-25A	25A(≥10V<150W)	≤25°C @ Max 150W	100°C	80~120DB	250mm X 190mm X 110mm
DLB-300W	2-200V	3mA-30A	30A(≥10V<300W)	≤25°C @ Max 300W	100°C	80~120DB	250mm X 190mm X 110mm
DLB-450W	2-200V	3mA-35A	35A(≥10V<450W)	≤25°C @ Max 450W	100°C	80~120DB	320mm X 270mm X 120mm
DLB-600W	2-200V	3mA-40A	40A(≥10V<600W)	≤25°C @ Max 600W	100°C	80~120DB	320mm X 270mm X 120mm

--Functional test interface--



--Key Botton operate Description--



- 1) Short press the "ON/OFF" button to start and stop, short press the upper left corner of the "M" button to move the cursor and then adjust the corresponding value with the "+/-" button
 - 2) Long press the "+/-" button at the same time to clear all accumulated data such as the current capacity, battery time, etc. (Long press the "ON/OFF" button to enter the background .also can be cleared in the background menu)
 - 3) Long press the "M" button and the function mode starts to flash, then short press the "+/-" button to select the function (CC/CV/CR/CP/BRT/PT)
 - 4) In OFF mode, long press the "ON/OFF" button to enter the background interface, then short press the "M" button to switch the setting column, and the "+/-" button to adjust the number
 - 5) Short press the "+/-" button in the constant current accuracy column of the background setting interface to switch the constant current accuracy (10mA Or 1mA)
 - 6) When the system is not supplying power, press and hold the "M" button and do not let go. Then power on again. Enter the splicing power option and jump to the actual power value before let go
 - 7) Long press the "M" button the function mode starts to flash, short press the "M" button again to enter the setting adjustment value of the time-limited discharge and Cut off voltage column value
- # I : Bluetooth indicator (Flashing waiting for Bluetooth connection, Long light indicates successful connection)
- # II : "+" Vave Increase Button (Short press the button to increase the number, long press the button to increase continuously,When the mode is flashing, short press the button to cycle backwards)
- #III: "M" Set Buton (Long press "M" key to start function mode, press "+" or "-" key to switch CC/CV/CP/CR/BRT/PT mode, long press "M" key to start function mode, short press "M" again Key to switch between Time Discharge and Cut off voltage. Press the "+" or "-" key to set the value, the default is OFF)
- #IV: "-" Value Reduce Buton (Short press the button to decrease the number and long press the button to decrease continuously. When the mode is flashing, short press to cycle forward)
- #V: "ON/OFF" Run ON/OFF Button(Short press the button, it is ON or OFF
Long press the button to enter the product background settings, and use the "M" button and "+" or "-" button to set the parameters)

--Two kinds of 1mA or 10mA current test gear--



Operation method: Long press the "ON/OFF" Button to enter the background, press the "M" Button, select 05 item: Precision of current: 010mA ●1mA, set by "+" or "-"
 (Tips: Start the test with a minimum of 3mA)

--Host Parameters and description--



1. Test various DC power inputs
2. Mini USB detection port inputs
3. Micro USB detection port inputs
4. Type-c USB detection port input

--Electronic load wiring diagram--

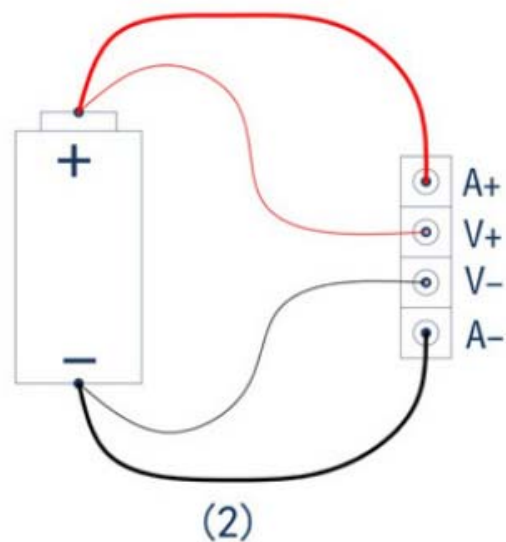
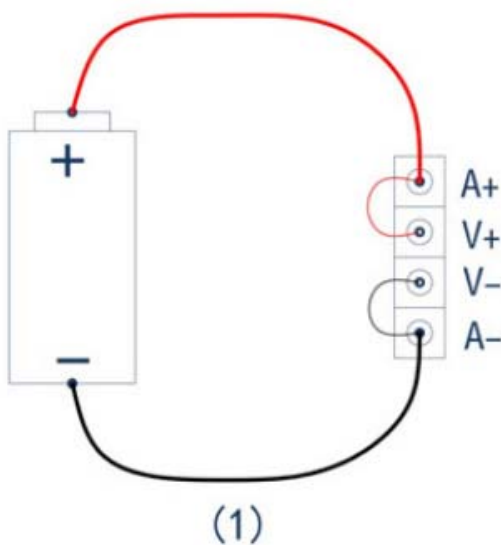

- (1) **Two-wire wiring method:** this method is relatively simple and convenient. Note: It must be connected to the 2 terminals [A+] and [A-].
- (2) **The four-wire wiring method:** the voltage measurement is not affected by the voltage drop of the wire, so that the voltage measurement. The quantity is more accurate, and it is recommended that buyers with a certain circuit basis use this method!

--Auto Detect Battery Internal Resistance Data--



--Intelligent one-key automatic detection of DC power supply--



III. Compatible with the current mainstream four online APPS

(Android/IOS/PC system) Online Testing

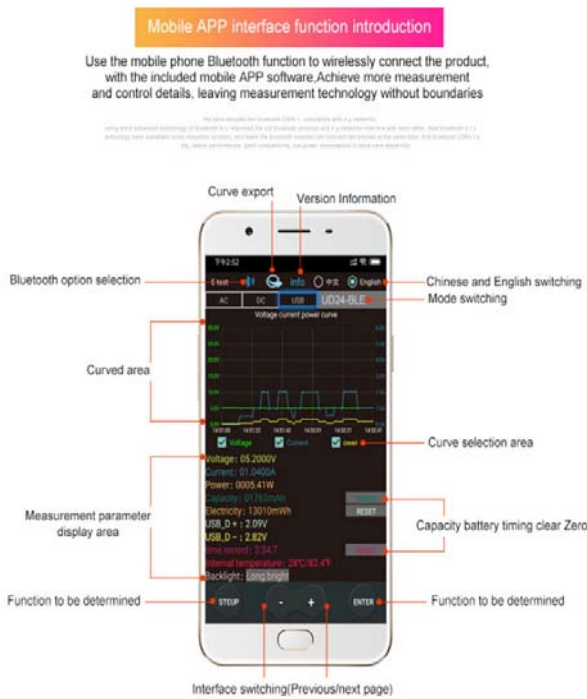

1) Apple Mobile APP:

Please search for **E_test** in the **Apple store** to download and install, then click the Bluetooth APP icon to open the software, and then click the Bluetooth icon above the software to enter the selection DL24-BLE to connect, you can achieve mobile phone remote wireless remote control settings and Measurement function, the discharge status can be viewed at any time on the mobile phone, various data cleaning is visible, the voltage and current power curve of the discharge, etc.

2) Android phone APP(Only support Android 5.0 and above):

Scan the QR code on the back of the host to download the corresponding APP software or Android APP: search **E-test** at Google play to download. After the installation is complete, open the software and click the Bluetooth icon to enter the direct selection of DL24-BLE to successfully use it online. (No need for Bluetooth pairing, the software Bluetooth icon directly selects DL24. can)

Android APP Download Address: <http://www.mediafire.com/folder/31bc15uhq8odb/E-meter>

3) Computer Bluetooth wireless online APP:

First add the Bluetooth device to the serial port device of DL24-SPP on the computer, then scan the QR code on the back of the host to download the corresponding APP software and store it. Open the software without installing and select the Bluetooth serial port model just added. You can successfully use online

--App Connection Method--



Please click this "E-test" APP to open the software

DLB Color Display Bluetooth Digital Control Curve Version Load Tester App Connection Method 150W/300W/450W/600W

1.Plug **DLB** into the USB charger and the Bluetooth indicator will light up.



2.Please download the mobile app software,only support Android 5.0 and above.

<https://www.mediafire.com/folder/31bc15uhq8odb/E-meter>

Then install the E-meter APP software on the phone.

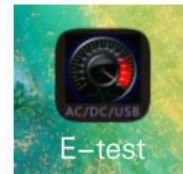

3.Bluetooth on the phone needs to be turned on,Then open E-test APP on the phone

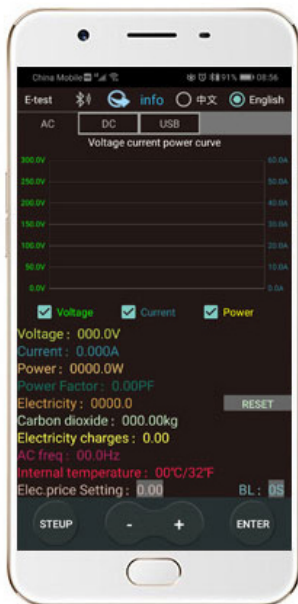

1

When the USB tester is powered on, the Bluetooth indicator is flashing, turn on the E-test App software icon, and allow Bluetooth to turn on.

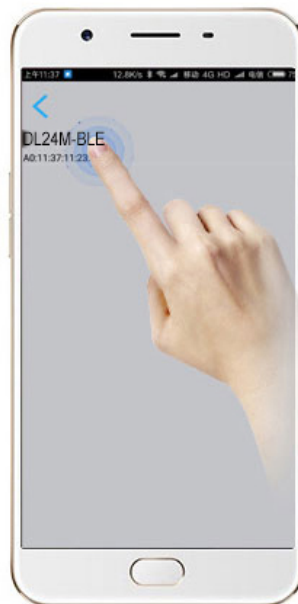

2

Click the Bluetooth icon in the upper left corner of the APP to pop up the menu for selecting the USB tester model. DL24M-BLE return to the main APP interface.

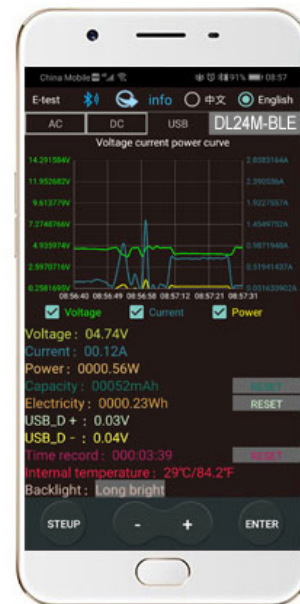

3

During the measurement, the upper right corner shows the model currently online. DL24M-BLE The bluetooth icon in the upper left corner turns blue, indicating that the measurement is in online communication.

How to find the Bluetooth symbol in E-Test APP

This operating instruction applies to all the company's Bluetooth products (UD18/DT24/DL24/AT3010/DPT3010/T18... etc.)

Please open your phone, **Setting**>>find the **Apps**>>manage the **Permissions**>>**Location**>>find our **E-test app**>>find the **storage information** and **location information**>>open the permissions **allow**, you can find us bluetooth symbol In the E-test list.



1 Please open your phone settings

Click settings

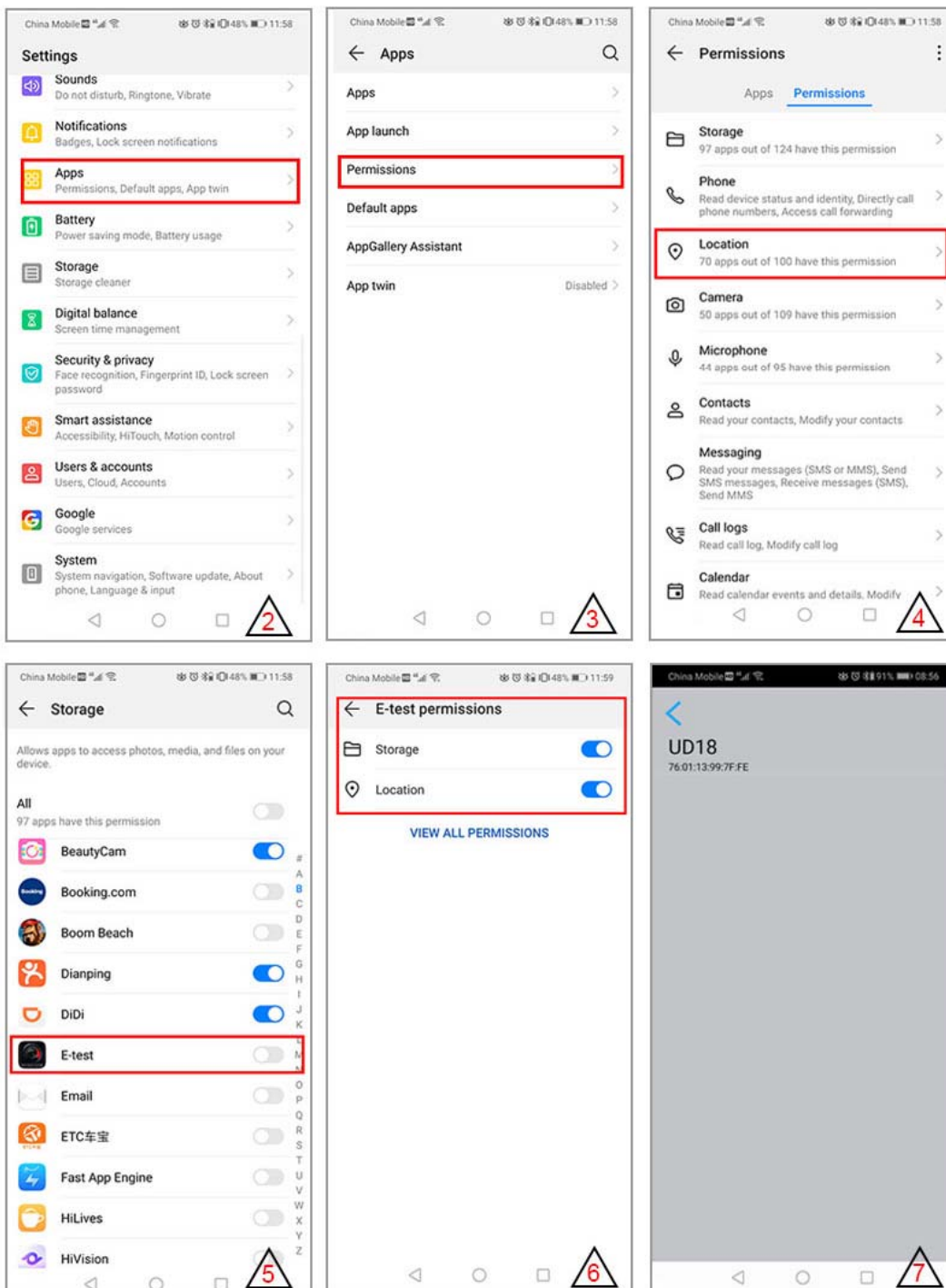

IV.Product List 150W

- 1.2.4 inch DC color screen 150W voltmeter X1pcs
- 2.Crocodile clip red black male and female X1 set
- 3.2.54MM terminal temperature probe X1pcs
- 4.12V 2A DC POWER SUPPLY X1pcs

DLB-150W@25A



250mm X 190mm X 110mm



200V 25A 150W

IV.Product List 300W

- 1.2.4 inch DC color screen 300W voltmeter X1pcs
- 2.Crocodile clip red black male and female X1 set
- 3.2.54MM terminal temperature probe X1pcs
- 4.12V 2A DC POWER SUPPLY X1pcs

DLB-300W@30A



250mm X 190mm X 110mm



200V 30A 300W

IV.Product List 450W

- 1.2.4 inch DC color screen 450W voltmeter X1pcs
- 2.Crocodile clip red black male and female X1 set
- 3.2.54MM terminal temperature probe X1pcs
- 4.12V 2A DC POWER SUPPLY X1pcs

DLB-450W@35A

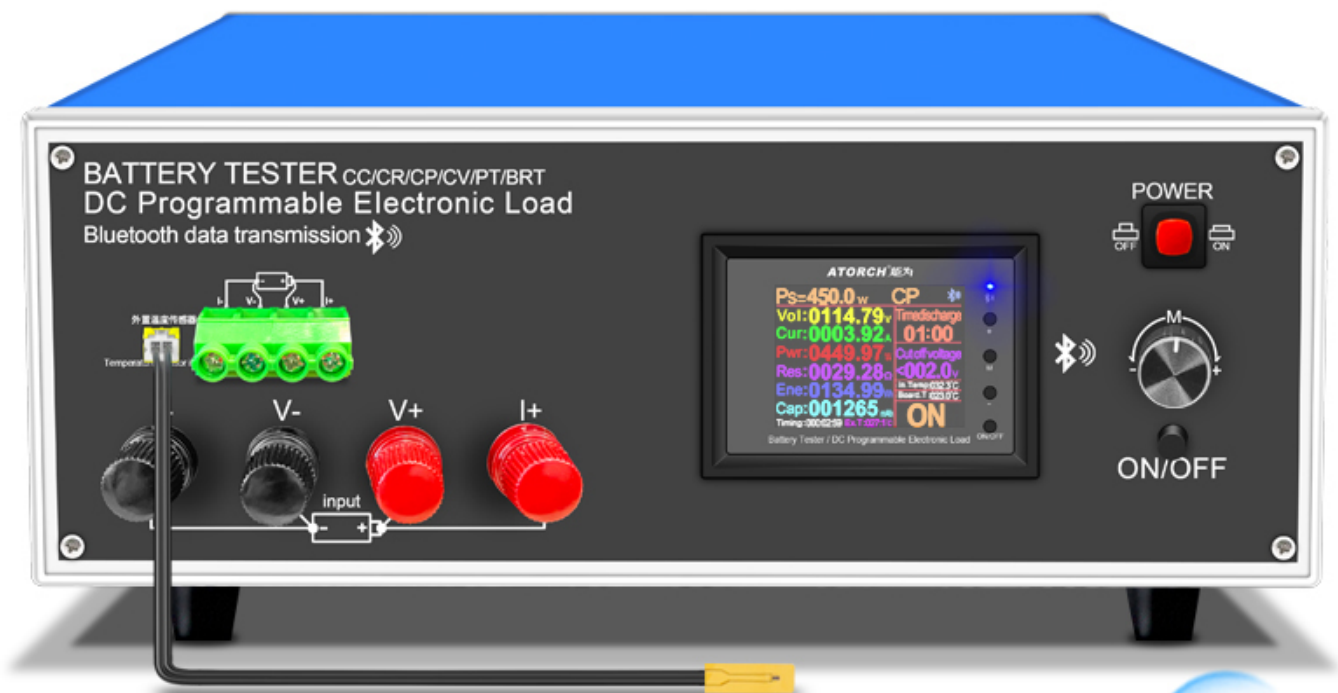

320mm X 270mm X 120mm



200V 35A 450W

IV.Product List 600W

- 1.2.4 inch DC color screen 600W voltmeter X1pcs
- 2.Crocodile clip red black male and female X1 set
- 3.2.54MM terminal temperature probe X1pcs
- 4.12V 2A DC POWER SUPPLY X1pcs

DLB-600W@40A



320mm X 270mm X 120mm



200V 40A 600W

--Product Shows--

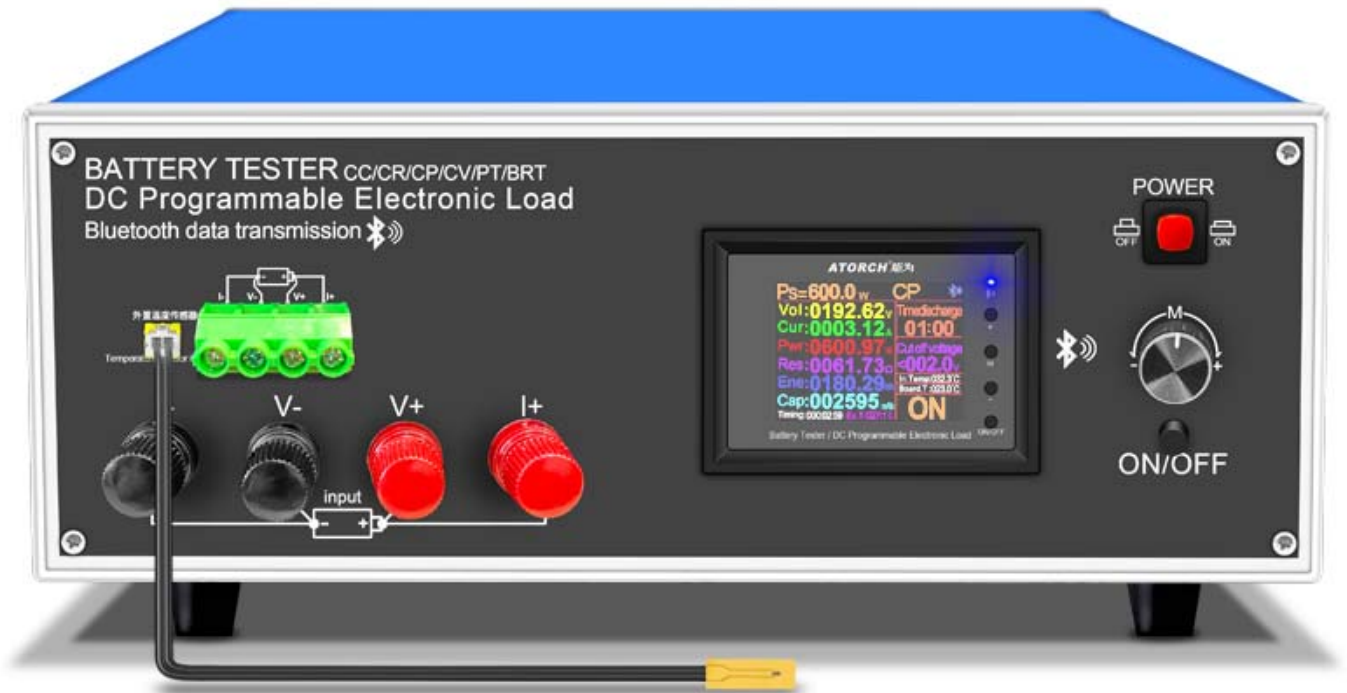



BATTERY TESTER CC/CV/CP/CV/PT/BRT
DC Programmable Electronic Load
Bluetooth data transmission

ATORCH 8-1
R=0011.36 CR
Vol=0030.12
Cur=0002.85
P=0079.81
P=0011.36
P=0110.93
Cap=001060
01:50
ON

POWER

ON/OFF







- 1, User manual, PC software installation instruction and PC software and Android APP download link : <https://www.mediafire.com/folder/wnfpdnqfxscj2/DLB600W>
- 2, IOS APP: search E_test on iphone APP store to download
- 3, Android APP: search E-test at Google play to down load